

TurboCycler Lite Gradient Thermal Cycler

TCLT-9610 、 TCLT-9620

Operation Manual

Ver 1.2



Copyright © 2025 Blue-Ray Biotech Corp.
All Rights Reserved.

Table of Contents

1. Safety Precautions	1
2. General Description	2
2.1 Features	2
2.2 Product Overview	3
3. Getting Started	7
3.1 Unpacking.....	7
3.2 Initial Operation.....	7
3.3 Lid Opening/Closing	8
3.4 Heated Lid	9
3.5 Loading the Reaction Vessel.....	10
3.6 Home Menu	11
4. User Folder Management	12
4.1 Quick Run Folder.....	12
4.2 Public Folder.....	12
4.3 Creating a New User Folder.....	12
4.4 Viewing a User Folder.....	13
4.5 Editing a User Folder	13
4.6 Removing a User Folder	13
5. Protocol Management	14
5.1 Creating a New Protocol	14
5.2 Editing (Viewing) a Protocol	17
5.3 Deleting a Protocol	17
6. Protocol Running Management	18
6.1 Running a Protocol	18
6.2 Monitoring the Protocol Running Status.....	19
6.3 Pausing a Running Protocol.....	20
6.4 Terminating a Running Protocol	20
7. Tools	21
7.1 Dry Bath.....	21
7.2 Tm Calculator	21
7.3 OD Convertor.....	21
7.4 Copy Number Convertor	21
7.5 Mastermix Preparation Wizard.....	21

8. History	22
9. System Setup	23
9.1 Administrator.....	23
9.2 Ramping Rate.....	23
9.3 Key Beep.....	23
9.4 Date & Time.....	23
10. Maintenance	24
10.1 Cleaning the Unit	24
10.2 Cleaning the Heated Lid	24
10.3 Replacing a Fuse.....	24
11. Troubleshooting.....	25
11.1 Error Messages.....	26
Appendix A: Technical Specifications	28
Appendix B: Template Protocols	29
Appendix C: CE Declaration.....	31
Appendix D: Order Information.....	32

1. Safety Precautions

Before using the **TurboCycler Lite** for the first time, please read this entire operation manual carefully. To guarantee problem free, safe operation of the **TurboCycler Lite**, it is essential to observe the following:

1. Do not use the device in a potentially explosive environment or with potentially explosive chemicals.
2. Install the device in a location free of excessive dust.
3. Avoid placing the device in direct sunlight.
4. Choose a flat, stable surface capable of bearing the weight of the device.
5. Install the device in a room with a temperature of 15 ~ 30 °C, relative humidity 20 ~ 80%.
6. **MAKE SURE** the air vents are unobstructed.
7. Keep the front and rear of the device at least 10 cm from the wall or other equipment.
8. Make sure the power source conforms to the required power supply specifications.
9. To avoid electric shock, make sure the device is plugged into a grounded electrical outlet.
10. Do not allow water or any foreign objects to enter the various openings of the device.
11. Switch off and unplug the device before cleaning, servicing, or replacing the fuses.
12. Repairs should be carried out by authorized service personnel only.
13. Safety label



High Temperature Label: Please be aware of the heated components.

2. General Description

The **TurboCycler Lite** is a powerful, reliable and affordable thermal cycler. It has a gradient function that enables the user to set a maximum 24 °C temperature gradient between the left and right columns in the sample block at each temperature.

2.1 Features

- Easy-to-operate lid design.
- The large liquid crystal module (LCM) display with touch keypad enhances visibility and ease-of-operation.
- The pressure preloaded lid with 35 ~ 120 °C adjustable heating temperature prevents the formation of condensation.
- A robust and modern looking design.
- Air intake vents on the front and exhaust vents on the rear reduce heat interference with other equipment.
- A simple and easy-to-use graphical interface.
- The gradient function enables optimization of annealing temperatures.
- Temperature increment/decrement function makes touchdown PCR possible. Unique design enables slow ramp incubation for CRISP/Cas related assay.
- Preset protocol templates make starting amplification easier.
- Automatically creates operating history and error logs.
- Auto restart of a running protocol after a power failure.

2.2 Product Overview

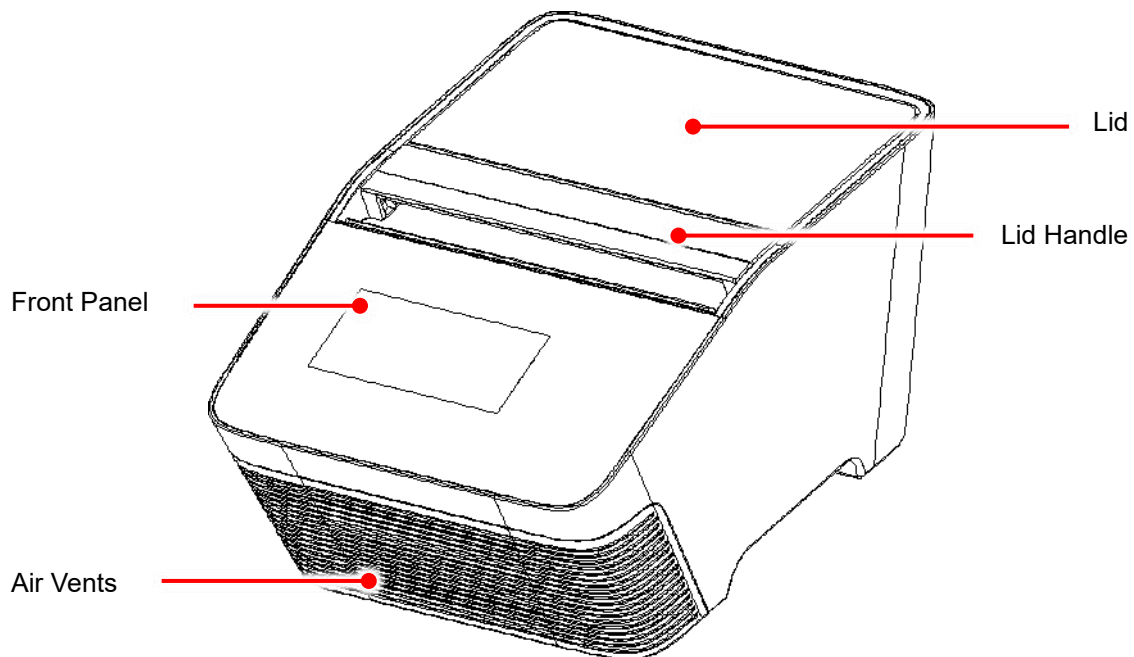

Figure 1. Top view

Table 1. Detailed description -- top view

Name	Function
Front Panel	5" 240 x 128 dots liquid crystal module with capacitive touch keypad displays the current system status and allows easy operation of the instrument.
Air Vents (Front)	For air intake.
Lid	The heated lid is designed to prevent condensation inside the reaction vessels during PCR temperature cycling.
Lid Handle	Easy-to-operate handle without a rotating lock that is designed to withstand long term operation.

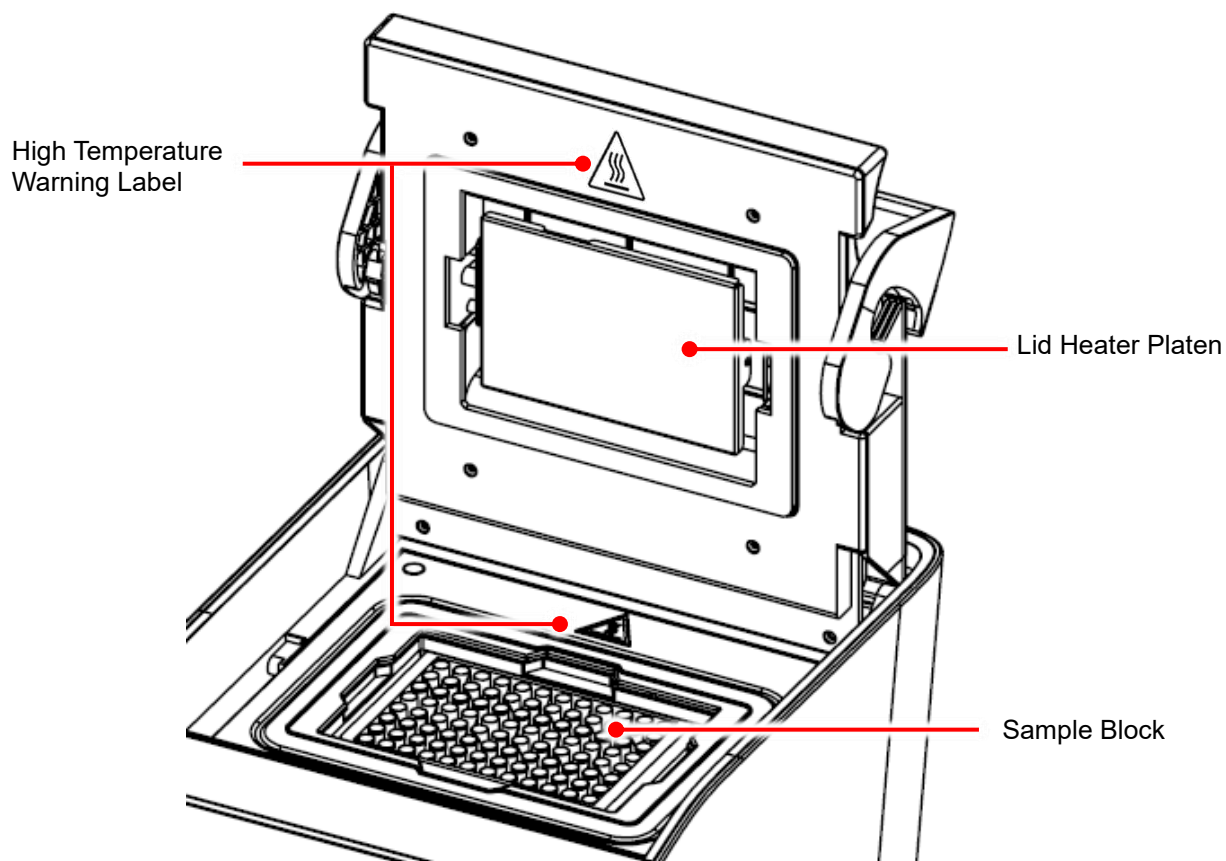

Figure 2. Top view with open lid

Table 2. Detailed description -- top view with open lid

Name	Function
High Temperature Warning Label	During and after PCR operation, the lid heater platen and the sample block may be very hot (up to 120 °C and 99 °C respectively). Please be aware of the high temperature.
Lid Heater Platen	The heater platen is designed to prevent condensation inside the reaction vessels and to place consistent pressure on the top of the reaction vessels. This pressure will ensure efficient contact between the reaction vessels and the sample block for good heat conduction. It will also help prevent the leakage of sample vapor due to weak vessel caps or sealing.
Sample Block	Section of the unit that holds the reaction vessels.

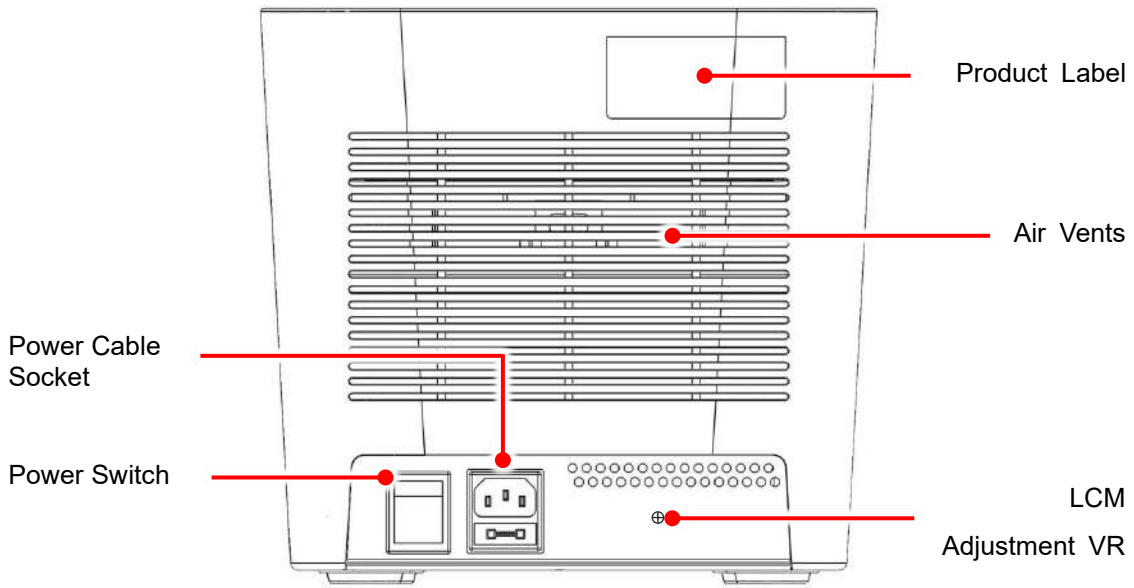

Figure 3. Rear view

Table 3. Detailed description -- rear view

Name	Function
Power Cable Socket	Power cable socket and fuse compartment.
Power Switch	Power On/Off switch.
Product Label	Indicates the model name, serial number, power specification, and other important information.
Air Vents (Rear)	For air outlet.
LCM Adjustment VR	Controls the contrast of the LCM panel. Please use a Philips screw driver to adjust.

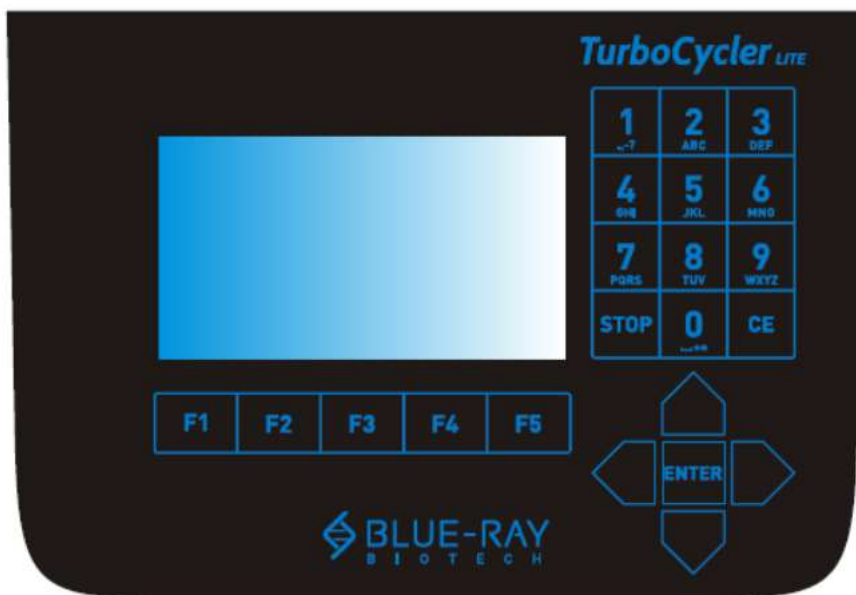

Figure 4. Keypad

Table 4. Detailed description of Keypad

Key	Key Representation
1	1 . , - ? ' # : ; /
2	2 A B C a b c
3	3 D E F d e f
4	4 G H I g h i
5	5 J K L j k l
6	6 M N O m n o
7	7 P Q R S p q r s
8	8 T U V t u v
9	9 W X Y Z w x y z
0	0 ␣ + = < > & () %
STOP	Stop the running protocol
CE	Cancel input and back space
▲ ▼ ◀ ▶	Selection keys
ENTER	Confirm the selection or input
F1 ~ F5	Function keys

3. Getting Started

3.1 Unpacking

Open the **TurboCycler Lite** package and confirm that all items below are included:

- **TurboCycler Lite** unit x 1
- Operation manual x 1
- Quick guide x 1
- Calibration report x 1
- Warranty card x 1
- 5.2 mm compression mat x 2
- 1.0 mm compression mat x 2
- European AC power cord x 1
- American standard AC power cord x 1
- Spare electric fuses 8 A x 1

If there are any items missing, damaged, or any incorrect items in the package, please contact your distributor or sales representative without delay.

3.2 Initial Operation

Place the **TurboCycler Lite** on a steady, flat table. Keep the front and rear of the device at least 10cm from the wall or other equipment. Check that the power source is compatible with the device fuse rating input. Connect the power cord to the power socket at the rear of the device.

Switch on the **TurboCycler Lite** using the power switch at the rear. The boot screen will be displayed for 5 seconds, and then the stand-by main screen will appear. The **TurboCycler Lite** is now ready for operation.

Switch the device off when it is not in use.

3.3 Lid Opening/Closing

To open the lid, pull the handle up and lift the lid back to the upright position as shown in Figure 5.

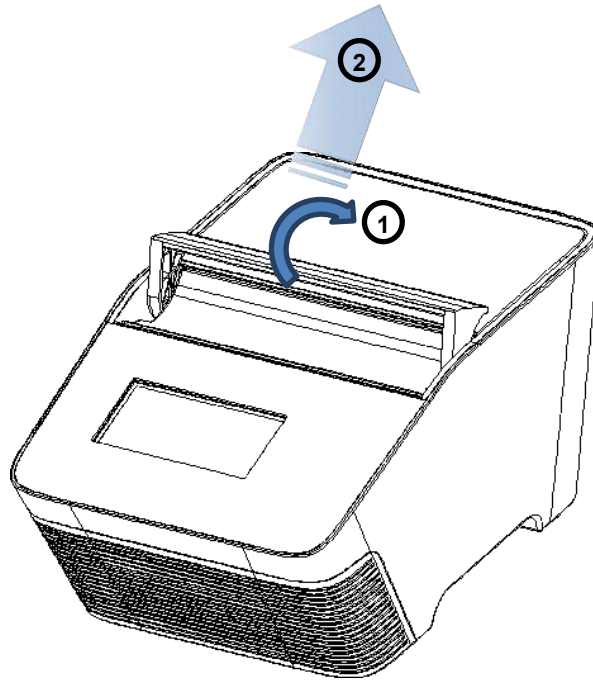

Figure 5. Opening the lid

To close the lid, pull the lid downwards and close the handle to the lock position as shown in Figure 6 below.

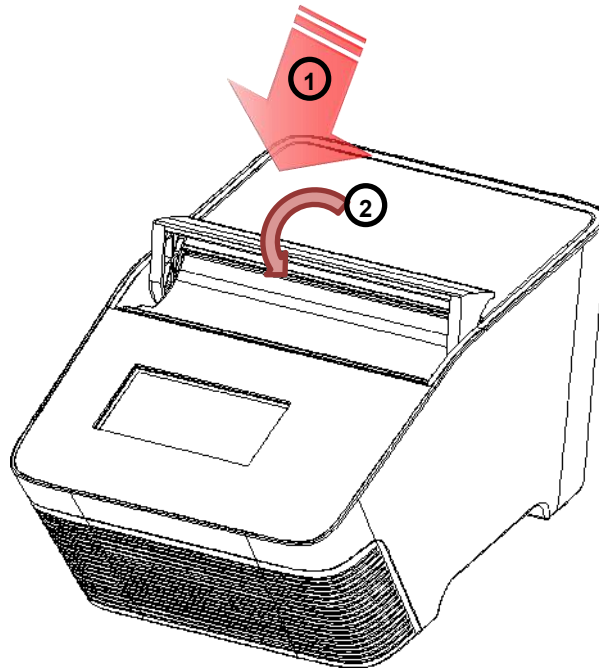

Figure 6. Closing the lid

3.4 Heated Lid

The Heated Lid raises the air in the upper part of the sample vessels to a temperature higher than that of the reaction mixture. This prevents condensation of evaporated water vapor on the vessel walls and keeps the concentration of the reaction mixture unchanged during the heating and cooling cycles. The heater platen also applies pressure to the caps or sealing film on the vessels to prevent vapor loss and cross contamination of samples.

Due to the height difference between standard profile vessels and the low profile vessels, it is necessary to use a 5.2 mm **Compression Mat** (standard accessory shipped with the **TurboCycler Lite**) for low profile vessels. The Compression Mat acts to place an even and sufficient pressure on the vessel caps or seals. Please refer to Table 5 for further information.

Table 5. Lid heater setting guide

PCR vessels	Compression mat	Lid heater temperature
Regular PCR plate, tube-strips and tubes	Not necessary. The 1 mm compression mat ² can be used to help maintain the sealing integrity in case the PCR plate has any imperfections on the rim of the well.	105 °C
Low profile PCR plate, tube-strips and tubes	The 5.2 mm compression mat ³ must be used to ensure sufficient contact pressure from the heated lid.	120 °C

Note

1. When the **TurboCycler Lite** is started from cold, approximately two to three minutes will be required for the heater platen to reach the set temperature. If low profile reaction vessels and the 5.2mm compression mat are used, an extra three minutes will be required to allow the compression mat to be heated to the required 120 °C temperature.
2. Standard accessory shipped with TurboCycler Lite. Extra **1.0 mm Compression Mats** can be purchased separately (Cat. # TCST-a003, pack of 10).
3. Standard accessory shipped with TurboCycler Lite. Extra **5.2 mm Compression Mats** can be purchased separately (Cat. # TCST-a002, pack of 10).

3.5 Loading the Reaction Vessel

For optimal performance of the **TurboCycler Lite**, the recommended sample volume for 0.2 ml tubes or 96-well plates is 10~100 μ l. For low profile vessels, it is necessary that a 5.2 mm Compression Mat be used to place even and sufficient pressure on the vessel caps or seals.

To apply the compression mat, follow the instructions shown in Figure 7.

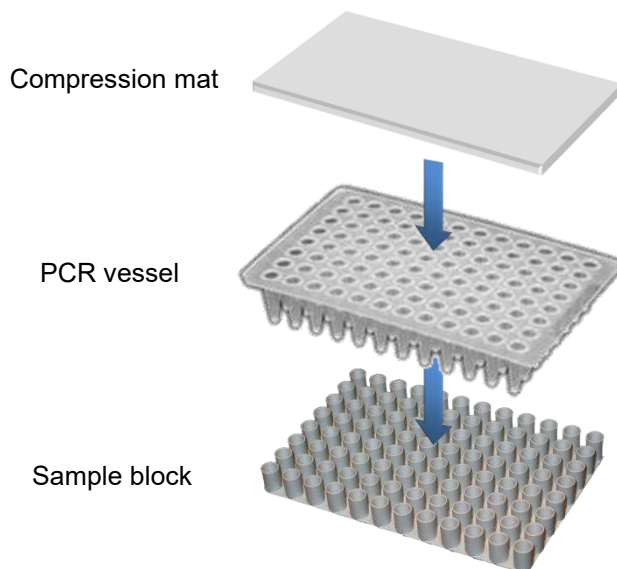

Figure 7. Using the Compression Mat

To prevent deformation of the PCR vessels, and to ensure even distribution of the pressure from the lid, when PCR tubes or tube-strips are used, please load extra empty tubes in the 4 corners of the sample block as shown in Figure 8. Always make sure that all the sample tubes/ tube-strips are distributed evenly on the sample block.

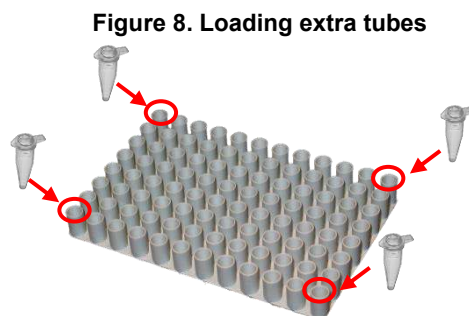

Figure 8. Loading extra tubes

3.6 Home Menu

The **Home Menu** has information about the status of the **TurboCycler Lite**, as well as six main function icons. Please refer to Figure 9 and Table 6 for detailed descriptions.

Figure 9. Main Screen overview

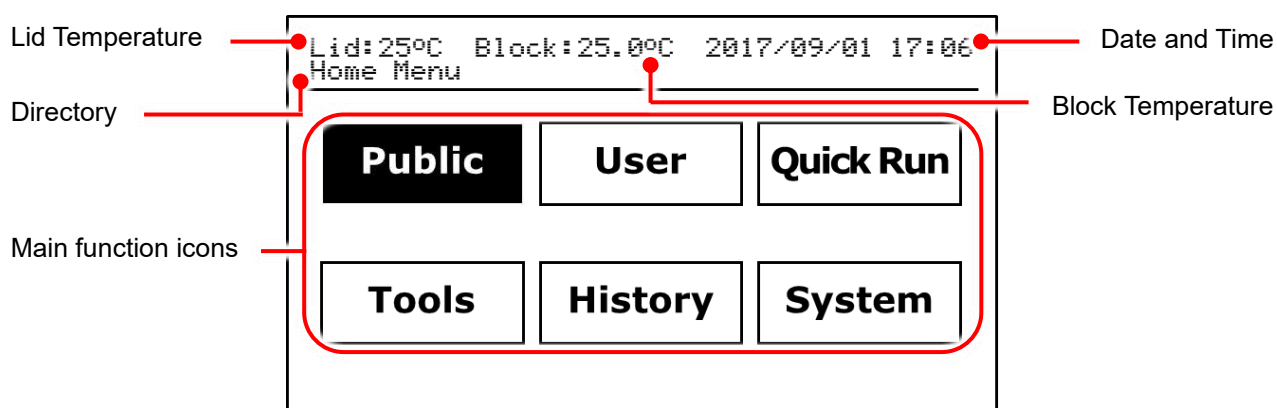



Table 6. Home Menu main function icons

Main function icons	
Public	Public folder Shortcut to the Public folder
User	User folder For user folder management
Quick Run	Quick Run Shortcut to the Quick Run folder
Tools	Tools Built-in assistance tools
History	History Protocol run history logbook
System	System setting For system management

4. User Folder Management

Select the **User** icon  on the **Home Menu** to enter the **User Menu**. A sample screen is shown in Figure 10 below.

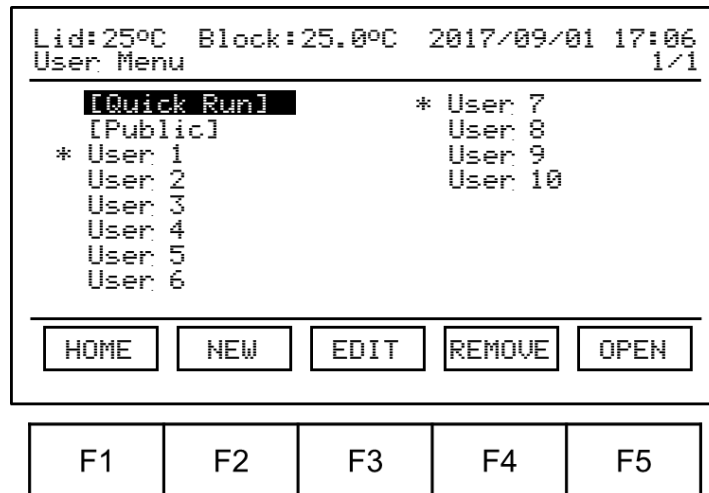



Figure 10. User folder overview

All protocols are stored in user folders. Up to 16 user folders are displayed on one page. The page number is displayed in the upper-right corner. Use the ▲▼◀▶ keys to highlight and select the user folder. The * indicates a PIN protected folder.

The function keys on the lower part of the screen can be used to open, create, edit and remove the user folders. The **F1** key  is used to return to the **Main Screen**.

Note

The **Quick Run** and **Public** folders are preset folders which cannot be deleted and require no password for entry.



4.1 Quick Run Folder

There are 5 preset protocol files in the **Quick Run** folder. These protocols can be edited and executed without the need for them to be saved.

4.2 Public Folder

The **Public** folder can be used to store the shared protocol files or files for temporary users.

4.3 Creating a New User Folder

Tap the **F2** key  on the **User Menu** to create a new user folder. Input the folder name and PIN (optional) and then tap the **F5** key  to save the changes.

4.4 Viewing a User Folder

To view the contents of a user folder, use the ▲▼◀▶ keys to select the folder, and then tap the **F5** key to open. If the folder is PIN protected, enter the PIN and then tap the **F5** key to confirm the PIN, or tap the **F1** key to abort the operation. If the PIN is entered correctly, the folder will open. An incorrect PIN will cause a warning message to be displayed. To run a protocol, please refer to Section 6.1.

4.5 Editing a User Folder

To edit the contents of a user folder, use the ▲▼◀▶ keys to select the folder then tap the **F3** key to edit. The folder name and PIN (optional) can be changed. Tap the **F5** key to finish editing and save the changes.

4.6 Removing a User Folder

To remove a user folder, use the ▲▼◀▶ keys to select the folder then tap the **F4** key to remove it. Enter the PIN if the folder is PIN protected. The system will prompt for confirmation of the operation. Tap the **F5** key to confirm the removal or tap the **F4** key to abort the operation.

Note

User folders which contain protocols cannot be removed. All the protocols in a folder must be deleted before it can be removed.

5. Protocol Management

A protocol list will be displayed after a user folder has been selected. A sample screen is shown in Figure 11 below. Up to 8 protocols will be displayed on each page. The page number appears in the upper-right corner. The function keys on the lower part of the screen can be used to edit, create, remove, and open the protocols. The **F1** key can be used to return to the **User Menu**.

Figure 11. Protocol list

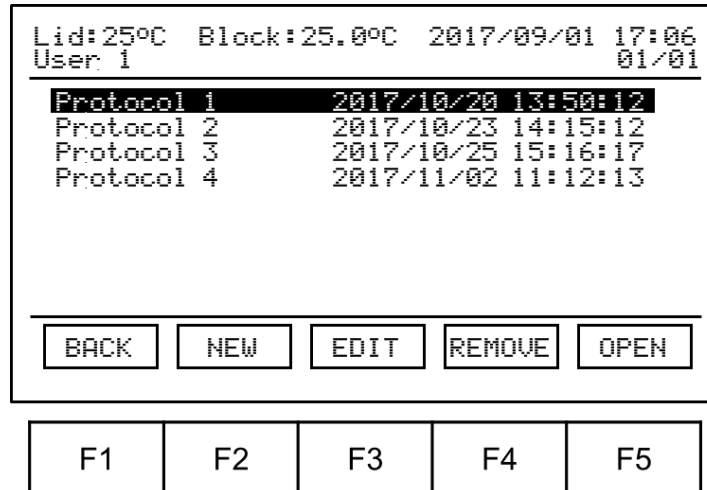

5.1 Creating a New Protocol

Tap the **F2** key to create a new protocol. You will be prompted to select a protocol template and input the protocol name. The protocol editing screen is shown in Figure 12 below.

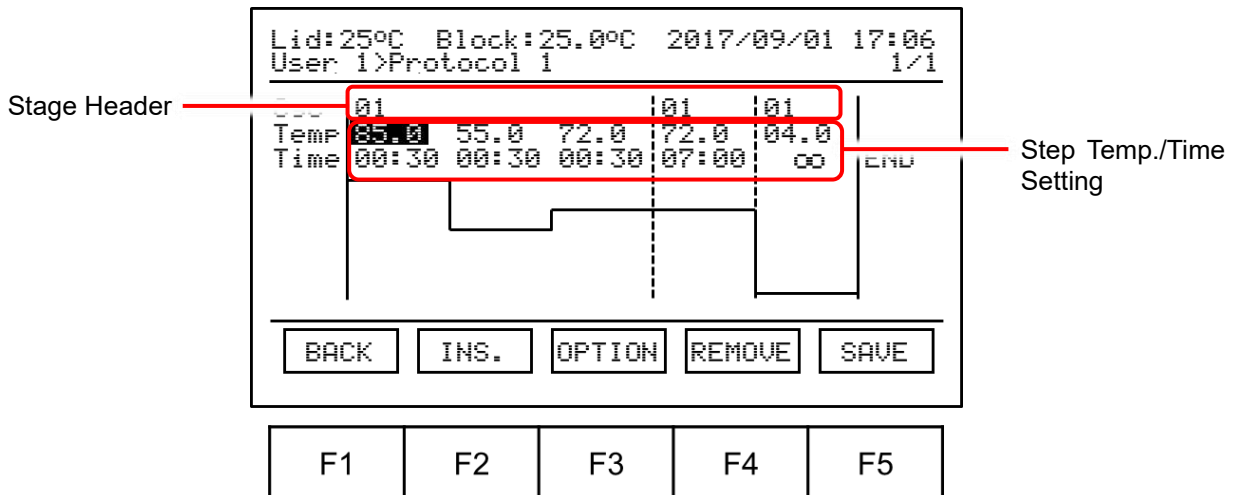

Figure 12. Standard Protocol Template

Use the ▲▼◀▶ keys to select the field to be modified, or use the function keys on the lower part of the screen to insert/remove stages/steps, change the advanced parameters or save the changes.

5.1.1 Changing the Stage Cycle Number

Select the stage header field, then use the alpha-numeric keypad to input a 2-digit setting value.

The Stage Cycle Number range: 01 to 99.

5.1.2 Changing Temperature/Time Setting

Select the step Temp./Time field, then use the alpha-numeric keypad to input the setting value.

The temperature and time ranges are shown below.

Temperature range (3 digits): 04.0 to 99.9 °C

Time range (4 digits): 00:01 to 99:59 mm:ss, 00:00 for infinity

Note

The infinity time setting is available in the last stage which contains only one step segment. This allows infinity hold to be set at the end of the protocol.

5.1.3 Inserting/Deleting a Stage or Step Segment

Use the ▲▼◀▶ keys to select the stage/step, and then tap the **F2** key to insert a duplicate stage/step, or the **F4** key to remove it. You will be prompted to confirm the operation. If a stage header has been selected, you will again be prompted to specify if this should be applied to the entire stage, or only to the first step. Tap the **F3** key or **F4** key to confirm the operation, or tap the **F5** key to abort the operation.

5.1.4 Advanced Option Settings

The following advanced option functions for the steps in a stage can be set up:

Note

1. If all the steps in a stage are deleted, the entire stage will be deleted.
2. If there is only one stage left in the protocol, it cannot be deleted.

- 1) **Gradient**
- 2) **Temperature Increment/Decrement**
- 3) **Time Increment/Decrement.**

Use the ◀▶ keys to select the step, and then tap the **F3** key . The **Option** screen will be displayed as shown in Figure 13.

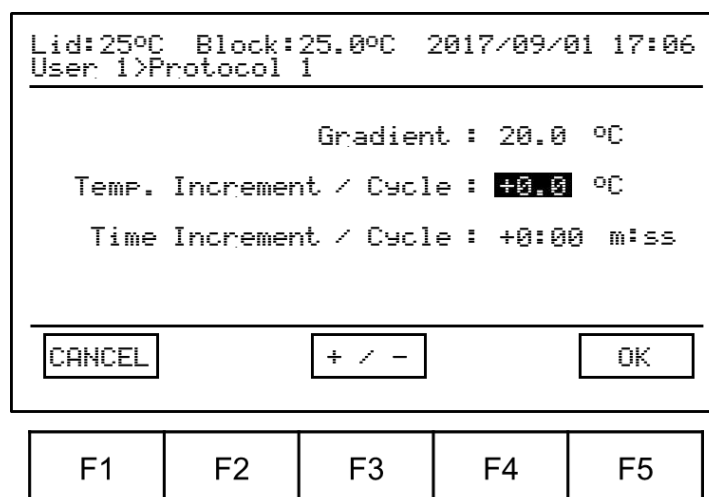

Figure 13. Advanced option

Use the ▲ ▼ keys to select the field to be modified, then use the alpha-numeric keypad to input the value to be set.

The option setting ranges are shown below.

Gradient temperature span (3 digits): 00.0 to 24.0°C, 000 turns off the gradient function.

Temperature incremental/decrement value (2 digits): -9.9 to +9.9°C

Time increment/decrement value (3 digits): -5:00 to +5:00 m:ss

Use the **F3** key to switch between + and – for Temp./Time input. Tap the **F5** key to confirm the setting or the **F1** key to abort the operation. If the gradient function is turned on, the temperature for 12 columns will be displayed.

Note

1. The temperature values between the 2nd and 11th columns are calculated values based on heat distribution throughout the sample block.
2. If the stage contains only one step, the gradient function for this step will be disabled. If the gradient function is turned on and set for a step in a multi-step stage, and all the other steps in this stage are removed later, the gradient function for this step will also be turned off and disabled.

5.1.5 Saving a Protocol

After all the settings have been entered, tap the **F5** key to store the protocol.

5.2 Editing (Viewing) a Protocol

To edit a protocol in the user folder, select it using the ▲▼ keys, and then tap the **F3** key to edit the protocol name. Use the **F5** key to open the file to modify the parameter settings. Please refer to **Section 5.1.1 ~ 5.1.5** to modify the settings and save the changes made.

5.3 Deleting a Protocol

Tap the **F4** key to delete a selected protocol in the user folder. The system will prompt for confirmation of the operation. Tap the **F5** key to confirm removal or tap the **F4** key to abort the operation.

6. Protocol Running Management



Caution: During the protocol running, the lid heater and the sample block may become very hot. Please be aware of the high temperature.

6.1 Running a Protocol

Please refer to **Section 5.2 Editing (Viewing) a Protocol** to open and check the setting of a protocol.

Tap the **F5** key to initiate the run. A request will be made for the user to select the temperature control mode of the lid heater and the sample block.

- 1 Lid heater temperature control mode.

Lid:25°C Block:25.0°C 2017/09/01 17:06				
User 1>Protocol 1				
Lid : OFF °C (35~120, 0:OFF)				
Volume : 000 ul (10~100, 0:Block Mode)				
<input type="button" value="BACK"/> <input type="button" value="OFF"/> <input type="button" value="105°C"/> <input type="button" value="120°C"/> <input type="button" value="OK"/>				
<input type="button" value="F1"/>	<input type="button" value="F2"/>	<input type="button" value="F3"/>	<input type="button" value="F4"/>	<input type="button" value="F5"/>

Figure 14. Lid heater control mode

Please refer to **Section 3.4** for detailed information. Use the alpha-numeric key pad to input a 3-digit setting for the lid heater. The **F2 ~ F4** keys can also be used to select from 3 preset lid temperatures. Tap the down selection key ▼ to shift to the sample block temperature control mode.

- 2 Sample block temperature control mode:
 - i. **Block Mode:** Enables system operation with maximum temperature control based on the actual block temperature regardless of the sample temperature. This mode is designed to mimic the control algorithm used in early model thermal cyclers.
 - ii. **Sample Mode:** Enables system operation with simulated temperature control. Users are required to input the sample volume: 10-100µl. In this mode, the temperature control algorithm will estimate the sample temperature based on the block temperature and sample volume. This is the mode recommended for normal operation.

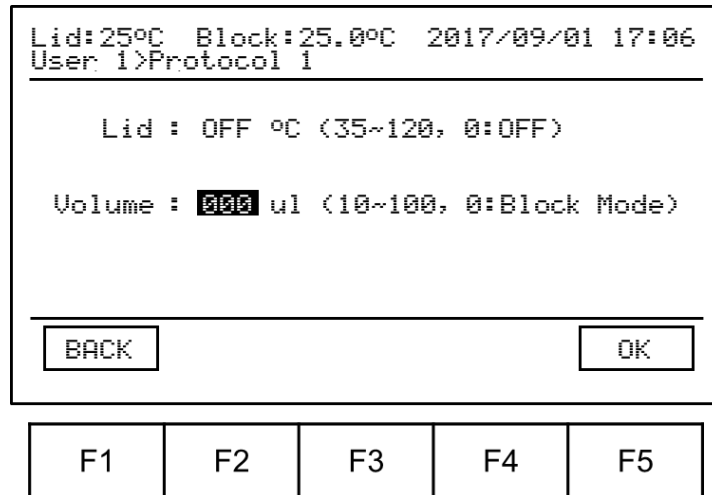

Figure 15. Sample Block control mode

Use the alpha-numeric keypad to input a 3-digit setting for the sample volume. Tap the **F5** key

to start the run.

6.2 Monitoring the Protocol Running Status

While the protocol is running, the status screen will be displayed as shown in Figure 16 below.

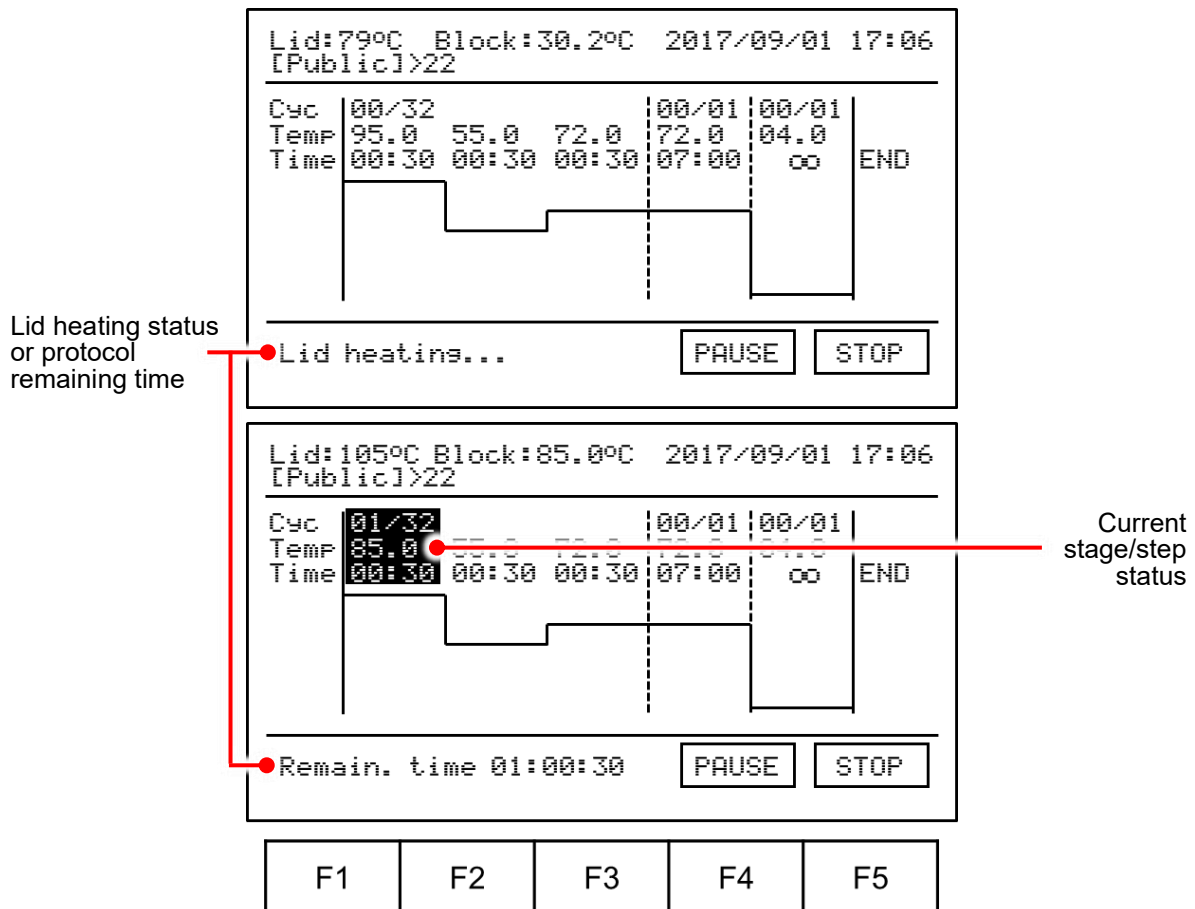

Figure 16. Running Protocol

Tapping the **ENTER** key will toggle between protocol running status and the big digit remaining time

display, as shown in Figure 17 below.

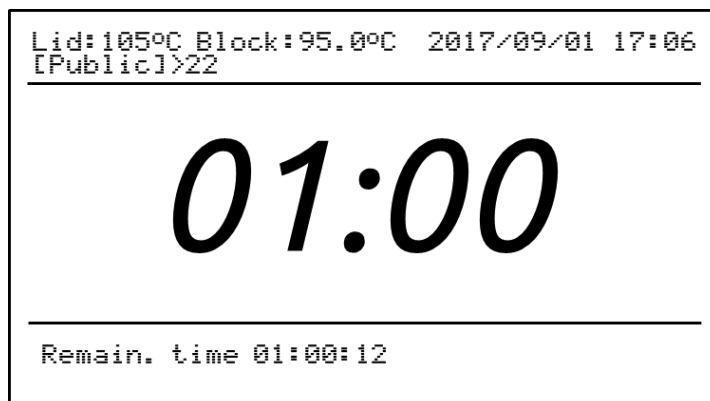

Figure 17. Remaining time

6.3 Pausing a Running Protocol

To pause a running protocol, tap the **F4** key and the system will prompt for confirmation of the operation. The protocol run will not be interrupted without confirmation. Tap the **F4** key to confirm and pause the protocol, or tap the **F5** key to abort the operation.

During the pause period, the temperature of the lid heater and the sample block will be maintained without change, but the countdown timer will stop running.

To resume the paused protocol, tap the **F4** key .

6.4 Terminating a Running Protocol

To stop a running protocol, tap the **F4** key . The system will prompt for confirmation of the operation. The protocol will not be interrupted without confirmation. Tap the **F4** key to confirm and stop the protocol run, or tap the **F5** key to abort the operation.

7. Tools

There are 5 built-in tools designed to assist users with routine tasks.

7.1 Dry Bath

The **TurboCycler Lite** can be used as a dry bath.

Temperature range (3 digits): 04.0 to 99.9 °C

Time range (3 digits): 0:01 to 8:00 h:mm, 0:00 for infinity

7.2 Tm Calculator

Calculate the Tm, length, GC% and the molecular weight for the input primer.

7.3 OD Convertor

Calculate the nucleic acid concentration from an OD measurement.

7.4 Copy Number Convertor

Convert the DNA concentration to a copy number.

7.5 Mastermix Preparation Wizard

Calculate the volume of the reagents needed to make the mastermix.

8. History

Select the **History** icon  on the **Home Menu** to enter the **History Menu**. A sample screen is shown in Figure 18 below.

Lid:29°C Block:30.2°C 2017/09/01 17:06			
History Menu 1/1			
Date	Time	User	Result
2017/10/26	17:22	[Public]	Cancel
2017/10/26	13:45	User 1	Finish
2017/10/26	12:45	User 2	Finish
2017/10/25	16:47	User 1	Finish
2017/10/25	15:35	User 1	Cancel
2017/10/25	15:25	User 3	Cancel
2017/10/25	14:42	User 2	Finish

HOME INFO OPEN

F1 F2 F3 F4 F5

Figure 18. History log list

To re-run a particular protocol, use the ▲▼ keys to select and then tap the **F5** Key  to open the protocol. Please refer to **Section 6.1 Running a Protocol**.

For further protocol run log information, use the ▲▼ keys to select and then tap the **F2** Key . A sample screen is shown in Figure 19 below.

Lid:29°C Block:30.2°C 2017/09/01 17:06			
History Information			
[Public]>22			
Start Time : 2017/10/25 17:35:23			
Finish Time : 2017/10/25 18:21:21			
Status : OK			
Protocol was completed Successfully!			
			Back

F1 F2 F3 F4 F5

Figure 19. Run log detail information

If an error is encountered during the running of a protocol, the error code will be recorded and displayed on the information screen. Please refer to **11.1 Error Messages** for detailed information.

9. System Setup

Allows the adjustment of several **TurboCycler Lite** parameters.

9.1 Administrator

The default Administrator password is “1111”. The Administrator privileges include the ability to delete any user folder and any protocols inside a user folder. The Administrator password and the Lab Name can also be changed from here.

9.2 Ramping Rate

The ramping rate (speed of temperature change) can be adjusted to accommodate the requirements for different experiments. A high ramping rate can speed up cycling and shorten the protocol running time. A low ramping rate can improve temperature uniformity during the heating and cooling phases and provide a more uniform result.

9.3 Key Beep

You can turn the key beep sound **ON** or **OFF** from here.

9.4 Date & Time

The date and time settings of the **TurboCycler Lite** clock can be made from here. The displayed date format can also be selected.

10. Maintenance

10.1 Cleaning the Unit

Please ensure that no liquid is spilled onto or into the unit. In addition, periodically wipe it clean of dust and other residue that comes with normal operation of the unit. Use a soft, lint-free cloth dampened slightly with deionized water. Air vents should be vacuumed to remove dust.

10.2 Cleaning the Heated Lid

Make sure the **TurboCycler Lite** has been turned off, is unplugged and has cooled down. Use a mild detergent to clean any residue from the lid. A Kimwipe™ dipped in 70% ethanol will help remove any sealing tape remnants. Make sure the lid is dry before the power cable is replaced.

10.3 Replacing a Fuse

The fuse is located in the power socket module, just below the power connector. If the power switch does not turn the unit on, you may need to check and replace the fuse.

To replace the fuse:

1. Disconnect the power cord from the unit.
2. Remove the fuse drawer with a small-bladed screwdriver.
3. Pull the fuse out of the socket and replace it with one having the correct current rating.
4. Use 8 A, 5 x 20 mm, glass fuse assembly.
5. Replace the fuse holder into the socket.

11. Troubleshooting

Problem	Cause	Action
The display is off even when power is switched on.	Power is not reaching the system.	Check power source voltage.
	Power cord is not plugged into the socket properly.	Reconnect the power cord.
	Power fuse is blown.	Replace the power fuse.
	Block fuse is blown.	Return the unit for service.
Block does not reach 4 °C.	Operating temperature environment may be unsuitable.	Operate the unit in a temperature environment between 15 and 30 °C.
	The electronic cooling element may be damaged or old.	Return the unit for service.
Cycle time is too long.	Operating environment temperature may be unsuitable.	Operate the unit in a temperature environment between 15 and 30 °C.
	The electronic cooling element may be damaged or old.	Return the unit for service.
	Faulty temperature sensor.	Return the unit for service.
Lid heater does not work.	Lid heater is set to off.	Check Lid Temperature setting in the System Menu.
	Lid sensor problem.	Return the unit for service.
No beep sound when tapping keys.	Key beep may be set to off.	Check Key Beep setting in System Menu.
	Faulty touch panel.	Return the unit for service.
The display goes off.	Faulty backlight.	Return the unit for service.
	Faulty LCM panel	Return the unit for service.
Display is too dark or bright.	Display brightness has not been properly adjusted.	Adjust Display Brightness Potentiometer.
Lid does not close properly.	Foreign object between lid heater and sample block.	Remove the foreign object or matter.
	Faulty lid lock mechanism.	Return the unit for service.
Error message appears.	Refer to list of error messages in Section 10.1 below.	Check the nature of the error and take the suggested action.

11.1 Error Messages

	Message	Cause	Action
01	ERR_LID_LIMIT	Lid temperature exceeds 132 °C.	Reboot the unit.
02	ERR_LID_SENSOR	Lid temperature sensor problem.	Reboot the unit.
03	ERR_LID_RAMPING	The room temperature is lower than 15 °C.	Warm up the room. Reboot the unit.
		Lid heater problem.	Reboot the unit.
04	ERR_LID_HOLDING	Lid heater problem.	Reboot the unit.
05	ERR_BLOCK_LIMIT_1	Block temperature exceeds 108 °C. 1 : upper left 2 : upper center 3 : upper right 4 : lower left 5 : lower center 6 : lower right	Reboot the unit.
06	ERR_BLOCK_LIMIT_2		
07	ERR_BLOCK_LIMIT_3		
08	ERR_BLOCK_LIMIT_4		
09	ERR_BLOCK_LIMIT_5		
10	ERR_BLOCK_LIMIT_6		
11	ERR_BLOCK_SENSOR_1	Block temperature sensor problem. 1 : upper left 2 : upper center 3 : upper right 4 : lower left 5 : lower center 6 : lower right	Reboot the unit.
12	ERR_BLOCK_SENSOR_2		
13	ERR_BLOCK_SENSOR_3		
14	ERR_BLOCK_SENSOR_4		
15	ERR_BLOCK_SENSOR_5		
16	ERR_BLOCK_SENSOR_6		
17	ERR_BLOCK_RAMPING_1	The room temperature is lower than 15 °C or more than 30 °C.	Maintain the room temperature within the 15~30 °C range. Reboot the unit.
18	ERR_BLOCK_RAMPING_2		
19	ERR_BLOCK_RAMPING_3	Block thermoelectric module problem. 1 : upper left 2 : upper center 3 : upper right 4 : lower left 5 : lower center 6 : lower right	Reboot the unit.
20	ERR_BLOCK_RAMPING_4		
21	ERR_BLOCK_RAMPING_5		
22	ERR_BLOCK_RAMPING_6		

23	ERR_BLOCK_HOLDING_1	Block thermoelectric module problem. 1 : upper left 2 : upper center 3 : upper right 4 : lower left 5 : lower center 6 : lower right	Reboot the unit.
24	ERR_BLOCK_HOLDING_2		
25	ERR_BLOCK_HOLDING_3		
26	ERR_BLOCK_HOLDING_4		
27	ERR_BLOCK_HOLDING_5		
28	ERR_BLOCK_HOLDING_6		
29	ERR_SYSTEM_FW	System software problem	Reboot the unit.
30	ERR_SYSTEM_UI		
31	ERR_SYSTEM_EE	System hardware problem	Reboot the unit.
32	ERR_SYSTEM_ADC		
33	ERR_SYSTEM_UNMI		

If the same error message appears after rebooting the unit, please return the unit for service.

Appendix A: Technical Specifications

Sample Block	
96 well, gradient block	Compatible with regular profile or low profile 0.2 ml PCR tube, strip, non-skirted, semi-skirted and full-skirted 96-well plate
Sample Volume	10 ~ 100 μ l
Block Temperature	
Block Temperature Range	4.0 ~ 99.9 °C
Max. Heating Rate	3.0 °C/sec
Max. Cooling Rate	2.0 °C/sec
Temperature Accuracy	+/- 0.3 °C
Temperature Uniformity Across Block	+/- 0.5 °C
Adjustable Ramp Rate	High / Low
Slow-Ramp Temperature Control	Via temperature increment / decrement between cycles
Gradient Temperature	
Gradient Direction	Horizontal across the block
Gradient Temperature Range	30 ~ 99 °C
Gradient Temperature Difference	Max. span 24 °C
Heated Lid	
Temperature Setting Range	35 ~ 120 °C or off
Temperature Accuracy	+/- 1.0 °C
Software	
Stored Program No.	200 sets
Registered User Folder No.	50 sets
User Folder Password Protection	Yes
General	
Display	5" Monochrome LCM, 240 x 128 pixels
Input Interface	Capacitive touch keypad
Auto Restart after Power Outage	Yes
Footprint Dimensions (H x W x D)	225 mm x 245 mm x 415 mm
Weight	9.0 kg
Power Supply	VAC 100 ~ 240, 50/60 Hz, 500 W
Standard	CE IVD, RoHS

Appendix B: Template Protocols

Step 2

Stage 1	94 °C, 5 min
Stage 2	94 °C, 30 sec
30 cycles	67 °C, 30 sec
Stage 3	72 °C, 7 min
Stage 4	4 °C, Hold

Step 3

Stage 1	94 °C, 5 min
Stage 2	94 °C, 30 sec
30 cycles	55 °C, 30 sec
	72 °C, 30 sec
Stage 3	72 °C, 7 min
Stage 4	4 °C, Hold

Gradient

Stage 1	94 °C, 5 min
Stage 2	94 °C, 30 sec
30 cycles	Gradient 55 ~ 70 °C, 30 sec
	72 °C, 30 sec
Stage 3	72 °C, 7 min
Stage 4	4 °C, Hold

Touch down

Stage 1	94 °C, 5 min
Stage 2	94 °C, 30 sec
30 cycles	60 °C (-0.5 °C/Cycle), 30 sec
	72 °C, 30 sec
Stage 3	94 °C, 30 sec
30 cycles	45 °C, 30 sec
	72 °C, 30 sec
Stage 4	72 °C, 7 min
Stage 5	4 °C, Hold

Time Increment

Stage 1	94 °C, 5 min
Stage 2 30 cycles	94 °C, 30 sec
	65 °C, 30 sec (+1sec/Cycle)
	72 °C, 30 sec
Stage 3	72 °C, 7 min
Stage 4	4 °C, Hold

Appendix C: CE Declaration



BLUE-RAY BIOTECH CORP.
4F., No. 31, Sec. 2, Chang-An E. Rd.,
Zhong-Shan Dist., Taipei City 10456,
Taiwan (R.O.C.)

Declaration of Conformity

Product Name: TurboCycler Lite

Model Names: TCLT-9610、TCLT-9620

All models comply with the following European standards:

EMC: EN 61326 (Group 1, Class A)

Safety: EN 61010-1 and EN 61010-2-010

To the best of my knowledge and belief, these units conform to these standards.

Name: Jimmy Kuo

Position: Quality Assurance Manager

Issue Date: 2017. 11. 4

Appendix D: Order Information

TCLT-9610	Gradient TurboCycler Lite with 96-well sample block (110 V)
TCLT-9620	Gradient TurboCycler Lite with 96-well sample block (220 V)
TCST-a002	5.2 mm Compression mat x 10
TCST-a003	1.0 mm Compression mat x 10

Blue-Ray Biotech Corp.

5F., No.2, Aly.2, Siwei Ln., Zhongzheng Rd., Xindian Dist., New Taipei City 23148, Taiwan(R.O.C.)

www.blue-raybio.com

P/N: 401-TCBR02-12